



Hornby Hobbies Limited, Margate, Kent CT9 4JX. Tel: +44 (0) 1843 233525

For more information visit: www.hornby.com

HORNBY®

TRAIN

CONFIG

DIGITAL

'Select' Unit - Operators Manual



Digital Command Control

Welcome to the digital Hornby World of model railways. You are about to enjoy a new and exciting experience when it comes to controlling and operating a model railway.

Using the keypad that is on the **Select** unit locomotives can be “called up” individually and operated just like the real thing. Imagine a busy marshalling yard where the locomotives are positioned close together and where by using the **Hornby Select Digital Controller**, Hornby digital locomotives can be manoeuvred from one place to another without having to worry about the complexities of having to connect metres of wiring to a bank of switches and isolating sections and hoping the whole thing will work!

The **Hornby Select Digital Control** has the ability to address 59 DCC locomotives and 40 points or accessories. The following instructions are a guide on how to get the best from your **Hornby Select Digital Control**. Please take a little time to read carefully through the instructions before you start to assemble the track. Should you have any questions then you can either contact Hornby via the Hornby DCC website (www.hornby.com), or write to Hornby using the email address: help.dcc@hornby.com

For more information visit: www.hornby.com

Hornby Digital Select

Setting Up	5
Quick Start	6
Second Loco Programming	7
Select Unit Additional Benefits	8
Double/Triple Heading	14
Analogue Locomotive Control	16
Locomotive Function Control	17
Re-setting the Control Unit	19
Walkabout Mode	20
Programming Track	22
Hornby Digital Decoder	23
Hornby Digital Points Decoder	24
Making Points ‘Live’	25
Glossary	26
Trouble Shooting	29
Notes	30



Select Unit - Fact File



Keyboard

The keyboard has 16 keys used to register and programme locomotives or accessories, set inertia or acceleration levels, direction settings, and for emergency stopping! The Select allows for 59 locomotives to be registered to the unit and 40 accessories. Each locomotive can be coded with up to 99 levels of acceleration or deceleration speeds.

Locomotives have an ID number allocated to them from 1 - 59 and similarly accessories are given numbers of 60 - 99.

Rotary Control

Once the locomotive required to run has been "called up" and the direction of travel has been decided the model is ready to go. By turning the rotary control clockwise the locomotive will move off with the speed being proportional to the amount the control knob has been rotated.

If an acceleration level has been chosen then a more gradual acceleration can be expected depending on the setting. To slow the locomotive down, the knob is turned anti-clockwise and similar to the acceleration programming, if a deceleration setting has been coded into the loco the model will gradually slow.

LCD Display

The LCD Display screen of the Select shows the number of the locomotive or accessory which is in the process of being selected. This number will flash until the function button is pressed.

The number will remain on the screen until another locomotive or accessory is chosen. The screen also displays various other functions and operating instructions that the Select features.

Power

The Select is powered by a 220-240V AC wall-mounted Switch Mode transformer which supplies 1amp 15V AC power to the track as well as power to an uncontrolled outlet which can be used as an alternative electrical source to provide power for point motors and accessories in the traditional analogue manner.

A larger 4 amp transformer is available for use with the Select unit which will provide additional power to the tracks allowing for more locomotives to be run simultaneously.

Setting Up

Assemble the track as per the instructions included with the set.

For DCC to operate at its full potential, it is important that the locomotives receive a strong and consistent signal from the **Select**. Ensure the track and connecting fishplates are clean. It is also advisable to secure the track using R207 Hornby Track Pins to prevent movement and loose connections. For advice about cleaning the track and locomotive wheels, see the Troubleshooting section.

Connecting the Digital Control Unit

1. Locate the terminals at the rear of the **Select** unit labelled 'Track'.
2. Locate the Track to the Controller Link Wire, and insert the black lead into Socket **A** and the black and white lead into Socket **B**. (These wires must not be inserted into mains socket outlets).
3. Locate the Power Input Track section on the track circuit.
4. Press down on the left hand button on the Power Input Track section and insert the black and white lead of the Link Wire into the socket and release the button.
5. Repeat the process, inserting the black lead into the right socket of the Power Input Track.

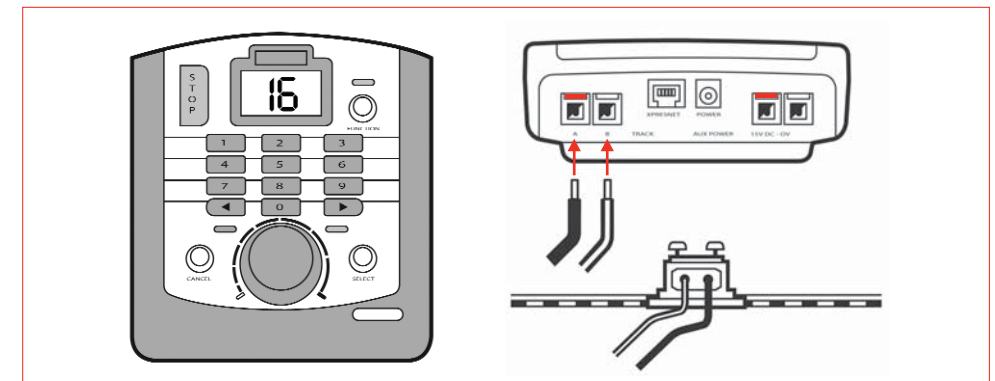

Connecting the Power Supply

1. Locate the Power Transformer with integral cable.
2. Locate the Power Input socket on the rear of the unit.
3. Take the Power Supply cable and insert the plug into the Power Input socket situated at the rear of the **Select** unit.
4. Plug the Power Transformer into the mains socket and switch on the power.

Please Note: There is no On/Off switch on the **Select** unit. Always ensure that the power supply is disconnected from the **Select** when not in use.

For more information visit: www.hornby.com

DIGITAL

Quick Start

Please Note:

During the start-up sequence of the **Select**, the LCD will briefly display the numbers 10 and 30 before displaying the default address 03. This is a system check for the **Select**, to ensure the unit is functioning correctly.

All Digital locomotives included in Hornby Digital sets are factory fitted with Decoders. These Decoders are programmed No. 3 as standard (default).

1. Place a locomotive on the track.
2. '03' will automatically be shown on the LCD (Liquid Crystal Display).
3. Turn the Control Knob on the **Select** clockwise until the locomotive has reached the desired speed.
4. To slow down and stop the locomotive, turn the Control Knob anti-clockwise.

6 Direction of travel is controlled using the Direction arrows on the unit keypad. The currently selected direction is indicated by a green LED (Light Emitting Diode) below the button.

5. To change the direction of the locomotive, press the opposite direction button to the one currently selected. IT IS RECOMMENDED YOU STOP THE LOCOMOTIVE BEFORE CHANGING DIRECTION.

Second Loco Programming

Before any programming can commence ensure that all locomotives are removed from the track, apart from the one to be coded with an alternative number (eg. No.1). Should any point decoders be connected to the track ensure that they are also disconnected as well.

All locomotives are coded as No. 3 at the factory. To change the code from No. 3 to No. 1 (for example) the following steps must be taken.

1. Place the locomotive you wish to program on the track.
2. Press and hold the "SELECT" button for 2 seconds. The LCD display will flash "LA" (Locomotive Address).
3. Press button **1** on the unit keypad. The LCD display will flash "1".
4. Press the "SELECT" button again to save the new locomotive address. The red LED will flash up to seven times during which the decoder will be accepting the command. If the LED flashes eight times, it is advisable to reprogramme the Decoder again.
5. The locomotive is now programmed as No. 1.

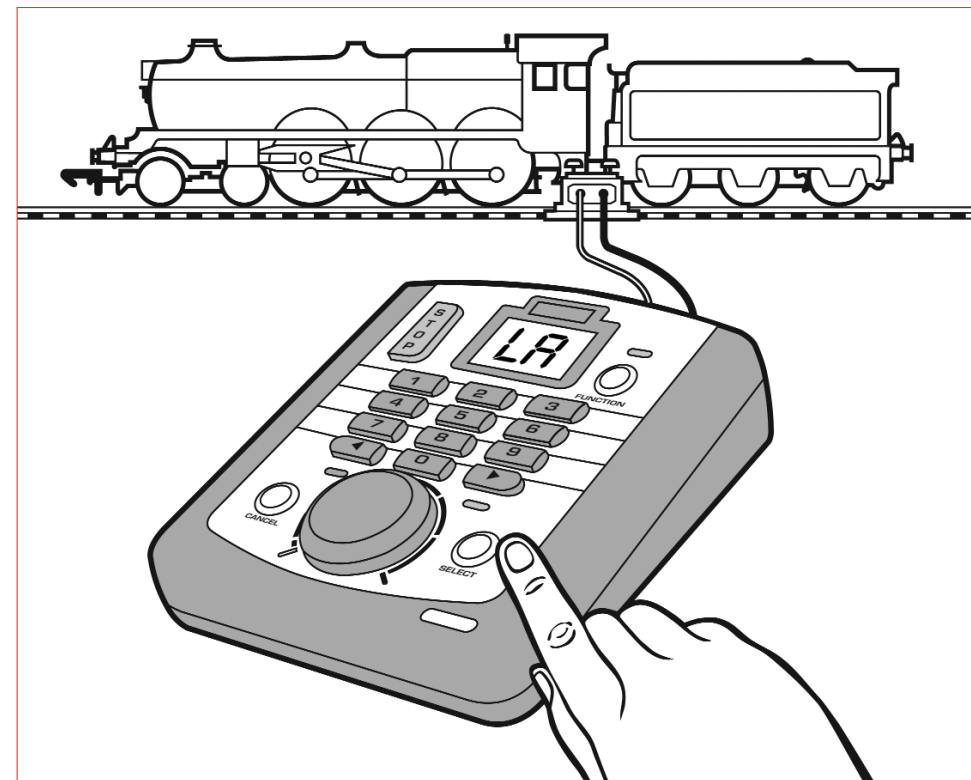

Select Unit Additional Benefits

Acceleration Control

Up to 99 acceleration and 99 deceleration levels can be programmed to each locomotive.

Acceleration Programming:

1. Ensure that the locomotive you wish to programme is the only one on the track.
2. Press and hold the "FUNCTION" button +  for 1 second.
The LCD display will flash "AC" (Acceleration).
3. Input the acceleration time by pressing the appropriate numerical key(s). The lower the numbers entered the faster the acceleration. The higher the number (maximum 99) the slower.
4. Press "SELECT" to confirm. The LCD will flash the deceleration level once. The red LED will flash up to seven times during which the decoder will be accepting the command. If the LED flashes eight times, it is advisable to reprogramme the Decoder again.
5. The LCD screen then changes to show the current locomotive address.
6. Turn the Control Knob and the locomotive will gradually accelerate at the speed level that was entered.

Please Note:

1 second per acceleration level (eg. an acceleration level of 10 equals 10 seconds approximately).

Deceleration Control

Deceleration Programming:

1. Ensure that the locomotive you wish to programme is the only one on the track.
2. Press and hold the Function button +  for 1 second. The LCD display will flash "dE" (Deceleration).
3. Input deceleration time by pressing the appropriate numerical key(s). The lower the numbers entered the faster the deceleration.
The higher the number (maximum 99) the slower.
4. Press "SELECT" to confirm. The LCD will flash the deceleration level once. The red LED will flash up to seven times during which the decoder will be accepting the command. If the LED flashes eight times, it is advisable to reprogramme the Decoder again.
5. The LCD screen then changes to show the current locomotive address.
6. Turn the Control Knob clockwise and the locomotive will gradually accelerate to the speed level that was entered previously.
Turn the Control Knob anti-clockwise and the locomotive will decelerate at the speed level that was input.

Important:

Should you wish your locomotives to have varying levels of acceleration/deceleration then you must programme them all individually. However if you require all your locomotives to have the same level of acceleration/deceleration you need not remove them from the track. In this instance programming one locomotive with acceleration/deceleration will programme them all.

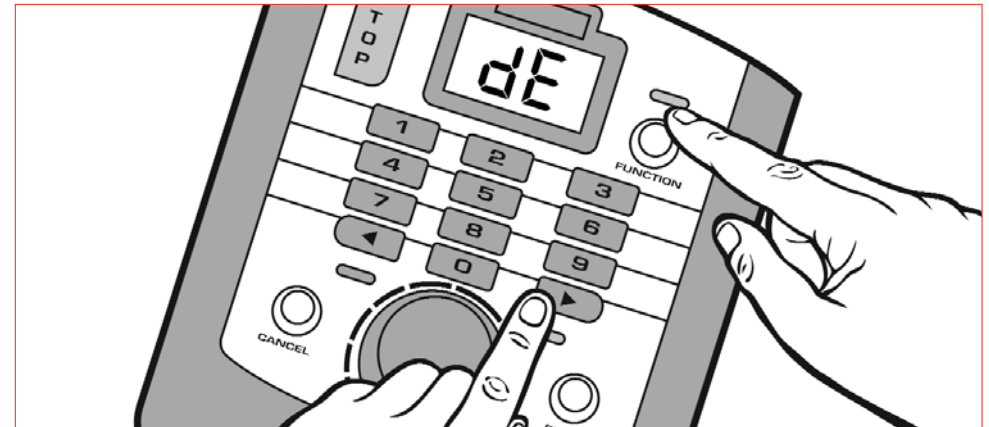

Adding a Further Locomotive

1. Remove all locomotives from the track apart from the one to be programmed.
 2. Decide on an address (eg. No. 2).
 3. Press and hold the Select button for 2 seconds. The LCD display will flash "LA" (Locomotive Address).
 4. Press button  on the unit keypad. The LCD display will flash "2".
 5. Press "SELECT" to confirm. The LCD will flash the deceleration level once. The red LED will flash up to seven times during which the decoder will be accepting the command. If the LED flashes eight times, it is advisable to reprogramme the Decoder again.
 6. The locomotive is now programmed as No. 02.
- Repeat this procedure for programming additional locomotives up to No. 59.

Please Note:

Ensure that the track circuit is always clear of locomotives other than the one chosen for programming. To add Acceleration and Deceleration see previous page.

Running a Locomotive

All locomotives included in the Hornby Digital Train Set range are factory fitted with Decoders. To achieve the maximum benefit of operating a Digital layout, ALL locomotives should be fitted with a Decoder.

1. Place one locomotive on the track, and select its address using the keypad.
2. To operate the locomotive, turn the Control Knob on the Control Unit clockwise until the locomotive has reached the desired speed.
3. To slow down and stop the locomotive, turn the knob anti-clockwise.
4. Direction of travel is controlled using the direction arrows on the unit keypad. Generally the currently selected direction is indicated by a green LED below the button. To change the direction of the locomotive, press the opposite Direction button to the one currently selected.

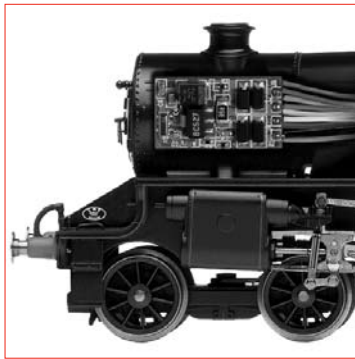

IT IS RECOMMENDED YOU STOP THE LOCOMOTIVE BEFORE CHANGING DIRECTIONS.

Running Multiple Locomotives

It is possible to have more than one locomotive running on the same track at the same time with the **Hornby Select Digital Control** unit. As an example it is assumed that there are three locomotives coded 1, 2, 3.

Operating Multiple Locomotives:

- Step 1.** Press **1** on the keypad and then "SELECT". Turn the Control Knob and locomotive No. 1 will begin to move.
- Step 2.** Press **2** on the keypad and then "SELECT". Turn the Control Knob and locomotive No. 2 will begin to move. Locomotive No. 1 will continue to run but will not respond to the controller until it is re-selected as per Step 1.
- Step 3.** Press **3** on the keypad and then "SELECT". Turn the Control Knob and locomotive No. 3 will begin to move. Locomotives No. 1 and No. 2 will continue to run but will not respond to the controller until re-selected again as per Step 1 or Step 2.

Please Note:

If locomotives 1, 2 and 3 are already programmed into the controller by repeatedly pressing the "SELECT" button, it is possible to scroll through the locomotives. For example by scrolling through and stopping at No. 2, No. 2 locomotive will respond to the controller. The speed of the locomotives will not change in relation to the position of the control knob while scrolling through addresses. When the Control Knob is turned again the speed will be adjusted on the currently selected locomotive.

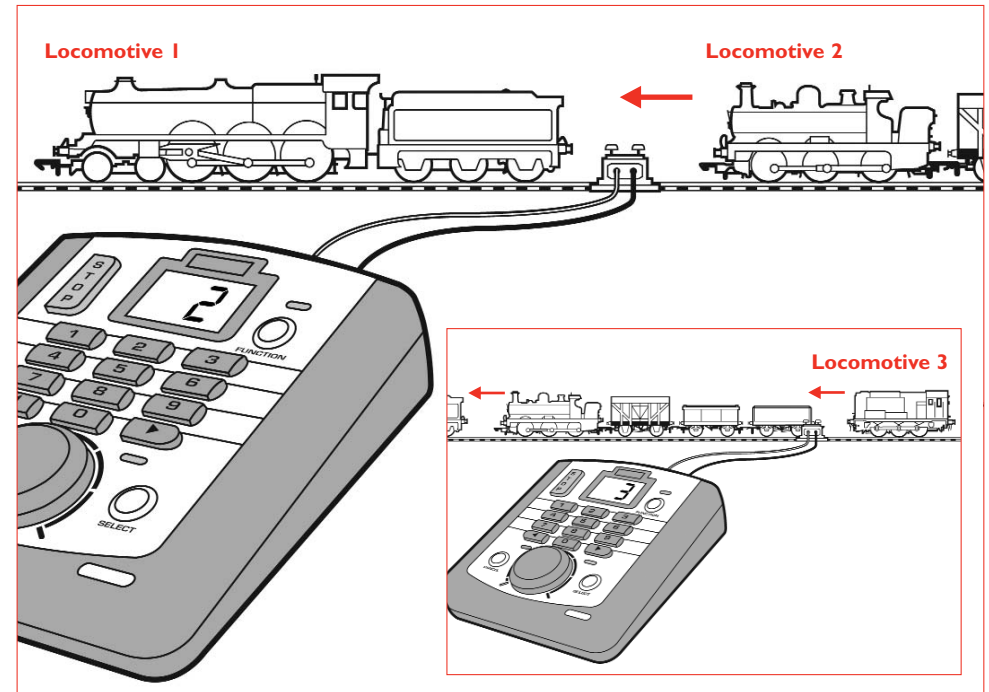

Important:

Should you wish your locomotives to have varying levels of acceleration/deceleration then you must programme them all individually.

However if you require all your locomotives to have the same level of acceleration/deceleration you need not remove them from the track. In this instance programming one locomotive with acceleration/deceleration will programme them all.

Selecting Locomotives

The **Select** control units feature two methods of “calling up” locomotives that are stored in the units memory. The keypad can be used to enter locomotive addresses directly, or the **Select** button can be pressed to cycle through the list of stored addresses.

Method 1: To select a locomotive address directly using the keypad.

1. Enter the locomotive address on the keypad.
2. Press “SELECT” to confirm.
The LCD Display will show the new locomotive address.

Method 2: To cycle through the locomotive address stored in the control unit’s memory...

1. Press “SELECT” repeatedly until the locomotive required shows on the LCD display.
2. The locomotive displayed can then be directly controlled.



Locomotive Control & Direction

It is a commonly accepted practice in the United Kingdom that when a locomotive is in operation, other than when shunting, the front of the locomotive normally faces to the left.

This is easy to determine when operating steam locomotives but not quite so obvious where a diesel or electric locomotive have double cabs. As a rough guide the front of a diesel has the roof fan closest to the front, while an electric locomotive’s front is determined by having the pantograph furthest away. These are general guides but are not necessarily absolute.

After assigning an address to a Locomotive, it may not move in the direction indicated by the green LED on the control unit. This can be corrected by the following procedure.

Correcting Locomotive Direction:

1. Ensure the locomotive is stationary.
2. Press and hold the unlit direction key ( or ).
The LCD will display either “Fd” or “rd” for one second.
The red LED will flash twice.
3. Press the unlit direction key.
The green LED will illuminate below the button.
4. Turn the Control Knob clockwise to move the locomotive.
5. The locomotive will now move off in the corresponding direction.

Emergency Stop

Running multiple locomotives on one layout has the potential for accidents and collisions to take place, if not properly managed. To help avoid such incidents, the Hornby Select Digital Control unit features an Emergency Stop button. Pressing this button causes all activity on the layout to cease.

Emergency Stop Procedure:

1. Press the “STOP” button located on the Select unit.
The LCD display will flash “E5” (Emergency Stop).
All activity on the layout will cease.
2. Turn the Control Knob fully anti-clockwise.
3. Press STOP to restore power to the layout. It will be noticed that all locomotives will remain stationary. To commence movement each locomotive will need to be reselected to the control individually. This will give the operator time to reorganise each locomotive’s movements.

Double/Triple Heading (Basic Consisting)

Double Heading

The **Hornby Select Digital Control** is capable of controlling 2 locomotives at the same time as if they are one entity.

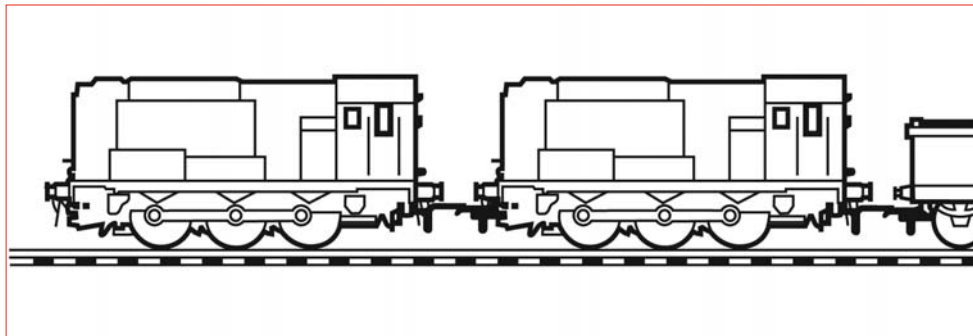

Creating a Consist: (Double Heading)

1. Place the locomotives you wish to Consist on the track. These should be programmed with individual addresses and set to the same direction.
2. Enter the address (between 0 and 59) you wish to use for the Consist, and press "SELECT". Ensure that the address used is different from the two locomotives you wish to Consist. The LCD displays the chosen address.
3. Press and hold "FUNCTION" for 1 second. The LCD display will flash "A1".
4. Using the keypad, enter the address of the first locomotive you wish to add to the Consist.
5. Press Select to confirm. The LCD display will flash "A2".
6. Using the keypad, enter the address of the second locomotive you wish to add to the Consist. Press "SELECT" and the LCD will display the Consist address.
7. The locomotives will now be Consisted, and can be controlled together.

Please Note:

When locomotives are placed in a Consist the levels of acceleration and deceleration will automatically default on the Consist locomotives to "0". If acceleration and deceleration levels are required follow instructions as per page 8. Note: When the Consist is dissolved the levels of acceleration and deceleration will remain at the levels set during Consist.

Dissolving a Double Triple Group:

1. Ensure all locomotives in the Consist are on the track.
2. Enter the address of the Consist you wish to delete and press "SELECT". The LCD displays the chosen address.
3. Press and hold "CANCEL" for 1 second. The LCD display will flash "CA".
4. The LCD will flash each locomotive address in the Consist for 2 seconds each.
5. The Consist has now been dissolved.
6. These actions refer to dissolving both double headed and triple headed groups.

Please Note:

As the Select is equipped for basic consisting some speed disparity between locomotives may occur. When the Consist is dissolved the levels of acceleration and deceleration will remain at the levels set during the Consist.

Triple Heading

To consist with 3 locomotives use one of 3 addresses as the Consist address. For example, use the following steps to create a Consist using 3 locomotives with Addresses, No. 1, No. 2 and No. 3.

1. Place the three locomotives you wish to Consist on the track.
2. Enter the address you wish to use for the Consist, in this example No. 1, and press "SELECT". The LCD displays the chosen address.
3. Press and hold "FUNCTION" for 1 second. The LCD display will flash "A1".
4. Using the keypad, enter the address of the first locomotive you wish to add to the Consist (No. 2).
5. Press Select to confirm. The LCD display will flash "A2".
6. Using the keypad, enter the address of the second locomotive you wish to add to the Consist (No. 3). Press "SELECT" and the LCD will display the Consist address.
7. The three locomotives will now be Consisted, and can be controlled in unison.

Please Note:

The **Select** can Consist a maximum of 3 locomotives.

Analogue Locomotive Control

It is possible but not recommended that a locomotive that is not fitted with a decoder (analogue) can be operated on a digital layout. This locomotive is given the address "0".

Running an Analogue Locomotive:

1. Press **0** on the keypad. Press "SELECT" to confirm. The LCD will display 00.
2. Turn the Control Knob clockwise to move the locomotive.
Pressing the **◀** or **▶** buttons on the keypad controls the direction of the locomotive.
The acceleration and deceleration of the locomotive is controlled via the Control Knob only.

Please Note:

If a digital locomotive is called up for operation the analogue locomotive will continue to run at the speed set prior to the digital locomotive being operated.

It is not possible to program into the analogue locomotive acceleration or deceleration levels.

When an analogue locomotive is placed on the track it will emit a high pitched noise when stationary, which will become louder when running, this is normal.

Only one analogue locomotive (No. 0) can be run on a digital layout at anyone time.

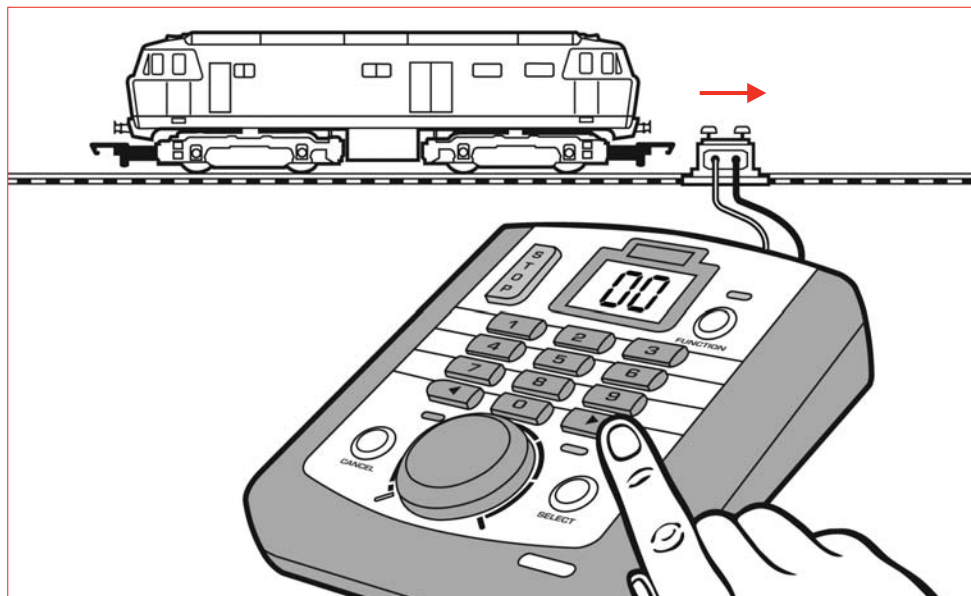

For more information visit: www.hornby.com

Locomotive Function Control

The **Hornby Select Digital Control** unit is capable of remotely switching on and off up to 9 functions which may be incorporated in to some locomotives. For example the locomotive may be fitted with lights, engine running sounds and a horn or whistle. Using the **Select** each function can be switched on or off.

If the locomotive has only one function (normally lights) then a "fast toggle" can be used.

Fast Toggle:

1. Enter the address of the locomotive you wish to control and press "SELECT" to confirm. The LCD display will flash the locomotive address.
2. Press the "FUNCTION" button. The LCD display will flash "F0", and the lights will go off.
3. Press the "FUNCTION" button again to turn the lights on.

Controlling Locomotive Functions:

For locomotives that have more than one function it is important that each function is noted and can be referred to by a number.

For example Lights = 0, bell = 1, horn or whistle = 2 etc.

To switch the functions On or Off the following procedure should be followed: In this example the horn will be switched on.

1. Enter the address of the locomotive you wish to control, and then press the Select button. The LCD will display the locomotive address.
2. Press and hold "FUNCTION" + **2** for one second. The LCD display will flash "F2" and the horn will be activated.
3. To turn the horn off, press and hold "FUNCTION" + **2** again.

Please Note:

The lights can also be turned on and off by pressing Function + **0**

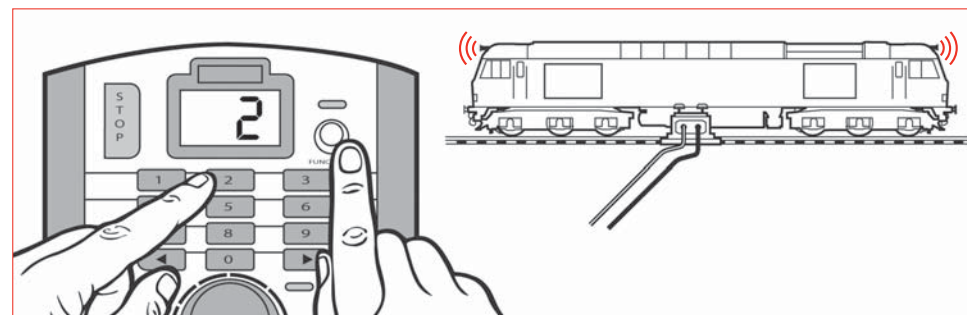

DIGITAL

Control Up to 10 Locomotives

The **Hornby Select Digital Control** unit can have stored in its memory 59 digitally controlled locomotives. At any one time the **Select** can have running (providing the power is available) or on standby 10 locomotives.

This is more than sufficient for an above average layout, however should an eleventh loco be “called up”, one of the previous 10 locomotives will be returned to the memory. The locomotive that is returned, will be the locomotive that has the lowest current Speed address compared to the other 9.

Alternatively, if all 10 locomotives are stationary, the locomotive with the lowest address number will be returned to the memory.

Power Boosters

The transformer included with the **Select** unit will probably provide enough power to allow for three locomotives to be running at any one time, providing the models used are fitted with power efficient motors. Should more power be needed the **Select** unit is capable of being connected to a R 8113 Hornby 4 amp Power Unit which should provide enough power for an average layout.

If under special circumstances even more power is needed it may become necessary for a “Booster” unit to be fitted. This will entail the track circuit to be broken up into large isolating sections to which the Booster is connected. The Booster will in turn be connected to the XpressNet port at the back of the Select unit.

There are several “Boosters” on the market, with each one supplied complete with the relevant fitting instructions.

Consult your Hornby DCC dealer for further details and advice.

15V DC Analogue Accessory Power Supply



The **Hornby Select Digital Control** unit incorporates a separate 15V DC outlet which can be used to power non-digital controlled accessories (analogue) such as point motors or similar devices as well as lighting.

Re-setting the Control Unit

Re-setting the **Hornby Digital Control Unit** will remove all previously assigned addresses from the units memory (with the exception of No. 3). Groups created for Double Heading will also be cleared from the units memory.

RESETTING THE CONTROL UNIT DOES NOT REMOVE ADDRESSES FROM LOCOMOTIVES.



To perform a reset:

1. Press and hold the STOP button +  + . The LCD display will display “C5” (Command Station).
2. Press Select. The LCD will display “0”.
3. Press Select. The red LED will flash 5 times to confirm the settings. The LCD will display “03”.
4. The **Hornby Select Digital Control** unit will now be restored to its factory settings.

Configuring the Control Unit

The Select is “Factory Set” when manufactured, however some of the basic settings can be altered by the operator. These settings include the ability to turn On and Off the ability to run an analogue locomotive on the layout. Other settings can be made to allocate additional controllers (See Walkabout Mode) to the Select controller.

Control Station - Switching Analogue Mode On/Off:

1. Press and hold the “STOP” button +  +  for 1 second. The LCD display will display “C5” (Command Station).
2. Press “FUNCTION” to toggle between C5 (Control Station) and HC (Hand Controller) modes. Ensure C5 is shown.
3. Press “SELECT” to select C5 mode. The LCD will flash twice and display “0”.
4. Press “FUNCTION” to toggle between 0 (enable) and -0 (disable) to enable/disable analogue locomotive modes.
5. Press “SELECT” to confirm your choice.
The RED LED will flash 5 times to confirm the settings.
The LCD will display “03”.

Walkabout Mode

The Hornby **Select** unit is capable of having connected to it up to 7 Select Walkabout units. The addition of these units to the **Select** will provide independent control of up to 8 locomotives providing electrical power is available. It is also possible that a locomotive can be passed from one controller to the next and then the next in much the same way as a full size steam train is handled on the main line.

Please Note:

When the Select and Walkabout are connected the transformer used with the Select will provide power to the Walkabout. Do not connect a power pack to the Walkabout while it is connected to the Select.

Connecting the Walkabout

1. Locate the XpressNet port situated at the rear of the Select Command Station unit and insert an RJ12 6 pin buddy cable. LCD will display "03".
2. Locate the XpressNet port at the rear of the Select Walkabout unit and insert the other end of the RJ12 6 pin buddy cable. LCD will display "HC".
3. Press "SELECT" to confirm. LCD will display "Ad" (Address).
4. Insert a number (1-31) which will be the Walkabout's address. For this example, press "1" and then "SELECT". Red LED will flash 5 times. LCD will then display the default setting/locomotive "03".
5. The Walkabout is now ready for use.

Operation 1 - Control of one locomotive by the Select and Walkabout

Example 1a: Using locomotive No. 1

Select Unit: Press "1" and then "SELECT". LCD will display "1".

Walkabout: Press "1" and then "SELECT". LCD will display "1".

Both units will now have the ability to control locomotive No. 1.

Example 1b:

1. Turn the **Select** control knob so locomotive No. 1 starts to move.
2. Next turn the Walkabout control knob.
The LCD, on the **Select** will flash "01" to indicate control of the locomotive is now being handled by the Walkabout.
3. Now turn the Select control knob so that the locomotive stops and the Walkabout LCD will start to flash.
This denotes that the **Select** unit now has control.
4. Next turn the Walkabout control knob so that the locomotive starts to move. The **Select** LCD display will not flash, indicating that the Select's control knob is fully in the "Stop" position.

Operation 2 - Controlling two or more different locomotives using the Select and Walkabout.

Example 1: For this example locomotive Nos. 1 and 2 are assigned to the Select and Walkabout.

1. Assign locomotive No. 1 to the Select.
The LCD will display "01"
2. Using the Walkabout key pad assign locomotive No. 2 to the Walkabout.
The LCD will display "02"
3. Both units will now operate independently from each other.
4. Both units can be used to "call up" and address other locomotives as per the Operating Instructions.
(See page 10).

It is possible for locomotives to be interchanged between the Select and the Walkabout while they are in motion. During this operation the locomotive concerned will remain at the set speed before being transferred. Once the control knob is moved full control is obtained.

Either the Select or the Walkabout can be used to programme locomotives. To program a locomotive, ensure all locomotives are removed from the track, other than the one to be programmed, and disconnect all point decoders. It is recommended that a Programming Track is used. See page 22.

Speed Step Change

There may be occasions when locomotives fitted with older generation decoders may make a 'guest appearance' on a **Select** controlled layout.

Some of these locomotives may require to have their Speed Step changed. To do this follow this simple procedure.

1. Press and hold "FUNCTION" + "CANCEL" for 1 second.
2. The Speed Step will increase with each press of "FUNCTION" + "CANCEL", 14, 28, and H5 (128).
3. Press "SELECT" to confirm the required Speed Step setting.

Programming Track

When addressing locomotives and Hornby Point/Accessory Decoders it is important that all other locomotives are removed from the track. It is also important that all point decoders are disconnected from the layout.

This can become rather difficult at times, therefore it is suggested that a Programming Track is used for the allocation of addresses. A Programming Track is a length of track electrically isolated from the main circuit but includes one Hornby R8206 Power Track and an R046 lever switch. To initiate the Programming Track, (see diagram below) use the Lever switch to connect or disconnect from the track layout.

To programme a locomotive follow the instructions on Page 7.

In respect of R8216 Point/Accessory Decoders it is not necessary for them to be in position and connected to their respective point motors for them to be programmed. It is much easier if they are programmed on the Programming Track. This is simply done by connecting the R8216 Point/Accessory Decoder to the track, (using the R602 Power Clip) supplied with the unit this will allow for the programming to be carried out as described on Page 25.

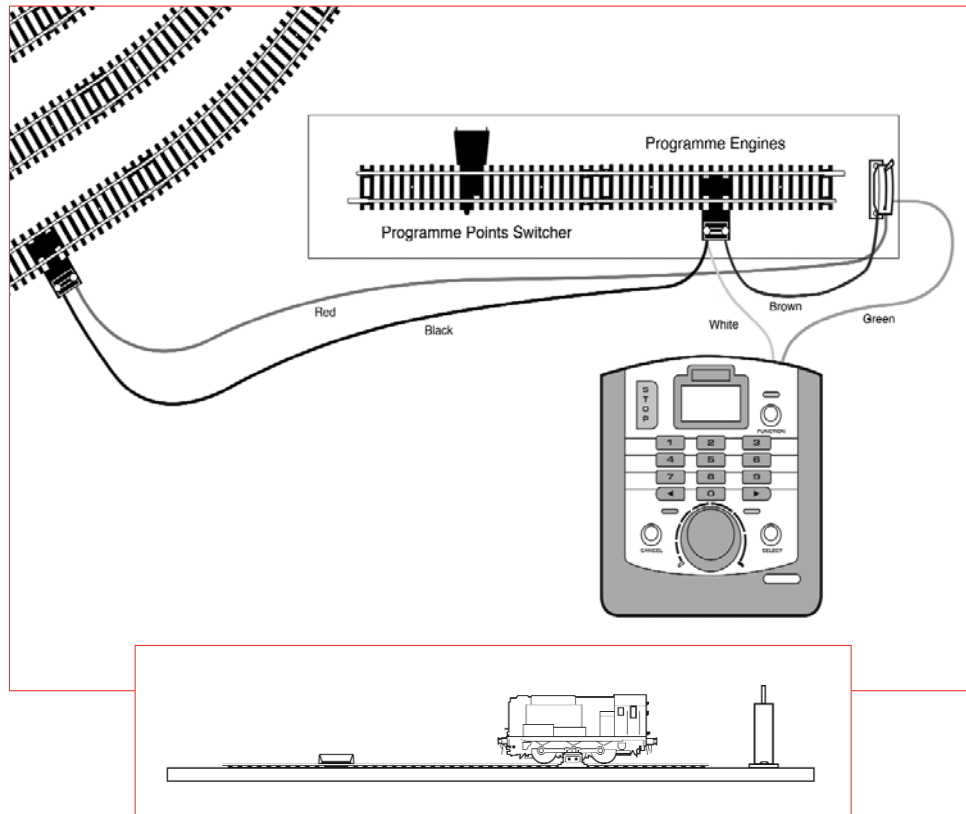

Hornby Digital Decoder

The four function R8215 **Hornby Digital Decoder** features:

Load compensation (Back EMF): Locomotive will run at a consistent speed either on the “flat” or on gradients.

Selectable for operation with 14, 28 or 128 speed steps: The greater the number of speed steps the smoother the acceleration. All Hornby decoders are factory set at 128 steps.

Four On/Off function outputs: Two of the function outputs are dedicated for the direction of lights-front and rear.

Analogue operation: Locomotives fitted with a **Hornby Digital Decoder** can be operated on an analogue system but without the benefits of digital control.

Overload cut-out: The **Hornby Digital Decoder** is rated at a 500mA continuous current and 1Amp for a short period. Should this be exceeded then the decoder will overload and cut out. This action protects not only damage to the decoder but also the locomotive.

Dimensions: 17mm x 10mm x 3.5mm



For more information visit: www.hornby.com

DIGITAL

Hornby Digital Points Decoder

The Hornby Select Digital Control is capable of operating up to 40 points or solenoid operated accessories when used in conjunction with the Hornby R8216 Points Decoder Module.

The Point Decoder Module can operate up to 4 points or solenoid operated accessories.

Fitting the Hornby Point/Accessory Decoder:

1. Connect the wires from the point accessory motor to the first available input terminals on the decoder. Then connect the wires from the point decoder to the track or Programming Track (see page 22). Full wiring instructions are supplied with each Module.

Addressing Points/Accessories:

Addressing a point motor or accessory that uses a solenoid motor is very similar to addressing a locomotive. For consistency it is advisable that the first point motor/accessory is addressed No. 60. Once addressed the other three outlets will be automatically programmed to 61, 62, 63. There after, the Accessory Decoder should be programmed in consecutive blocks of 4 (i.e 64, 67, 72, 75 etc). When programming subsequent Point Decoders ensure that other Point Decoders are disconnected from the track.

Programming:

1. Press and hold "SELECT". The LCD display will flash "LA".
2. Enter the first address (60) on the keypad, and press "SELECT". The red LED will flash up to seven times during which the decoder will be accepting the command. If the LED flashes eight times, it is advisable to reprogramme the Decoder again.
3. The point/accessory is ready for use. The other outlets have been automatically coded 61, 62, 63.

Operation:

Using the direction buttons (◀ and ▶) the points/accessories can be controlled.

1. Press ▶ Point changes. The LCD will display "P5" for one second. The corresponding green LED will illuminate for one second.
2. Press ▶ Point changes. The LCD will display "P6" for one second. The corresponding green LED will illuminate for one second.



For more information visit: www.hornby.com

Making Points 'Live'

The Hornby Select unit operates most efficiently when the whole of the layout is "live". Hornby points are self isolating therefore it is necessary to fit each point with 2 x R8232 Hornby DCC Electric Point Clips. Some of these clips are included in the Hornby DCC sets, further clips are available from Hornby stockists.

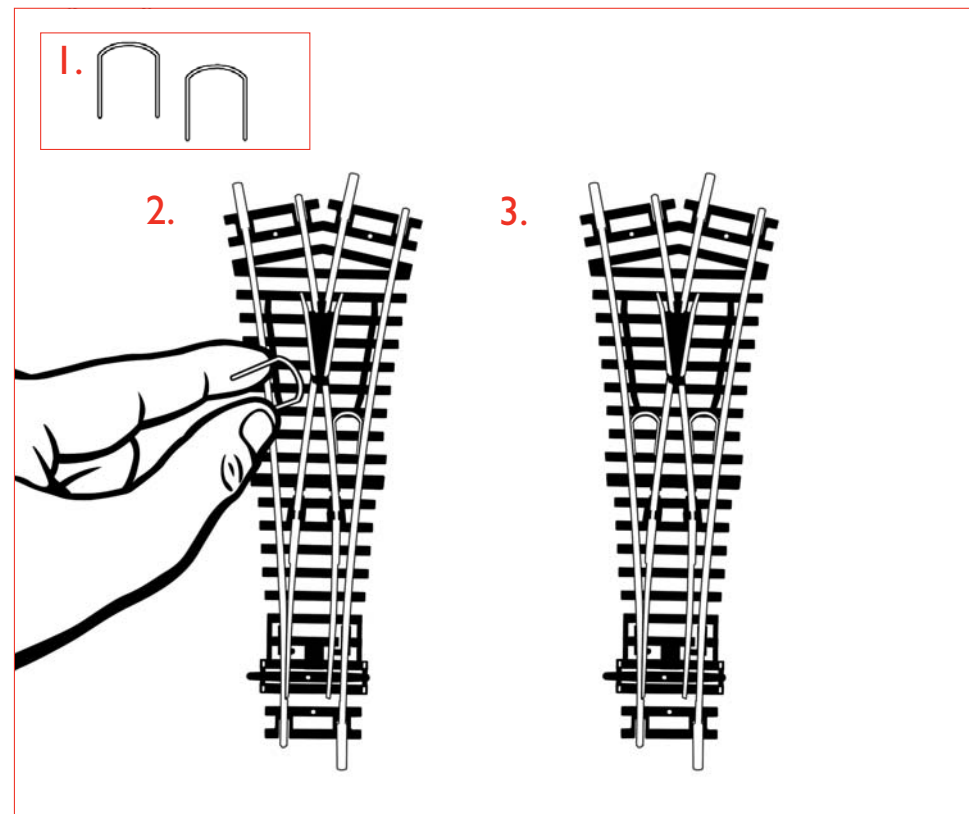

Please Note:

Always use Hornby Point Motors with Hornby points.

DIGITAL

Glossary

Acceleration Delay

The delay between the locomotive being stationary and reaching the desired speed.

Accessory Decoder

An electronic decoder designed for use in track side accessories such as points or signals. An accessory decoder is not for use in a locomotive.

Address

A number used to identify a locomotive or accessory that is either equipped or linked to a Decoder.

Bus

Technical term for wires that carry electrical signals around a model layout.

Command Station

The Command Station is the 'brains' of a DCC system. A Command Station is in essence a micro-computer/controller that communicates with the decoders that are located either in a locomotive or connected to accessories. The computer transmits signals to the decoders instructing them what to do, such as accelerate, decelerate, brake or switch lights on or off.

Configuration Variable (CV)

A technical term referring to the operating information of the particular locomotive or accessory that is stored on the specific decoder. This information will remain "set" until changed using the Command Station.

Consist/Consisting

Consist is an American term, but in the UK it is known by Double or Triple Heading. This is where two or more locomotives are brought together and function as one.

There are three types of Consisting (1) Basic consisting where the locomotive decoders in the Consist have the same address. (2) Universal Consisting where the Consist information is stored in the Command Station. (3) Advanced Consisting is where the Consist information is stored inside the decoder.

DCC

Digital **C**ommand **C**ontrol. The application of computer technology to control the movements of locomotives. Each locomotive is fitted with a decoder (or 'chip') which is uniquely programmed and recognises its own identity and responds only to those control signals which are addressed to it.

DCC also allows a wide range of extras including controllable lighting and on-board sound. The accepted standards have been laid down by the NMRA (National Model Railroad Association) an American Association.

Deceleration Delay

The delay of a locomotive slowing down to a standstill.

Feedback (Load Compensating)

This allows a locomotive to remain at a constant speed regardless of loads being pulled or incline being negotiated.

Locomotive Decoder

A small PC board which contains a 'chip' that stores control information; normally fitted in locomotives. The Command Station sends coded information to the decoder which can then control the locomotives speed, direction and any operating functions that the locomotive may have eg lights.

Locomotive Decoders can be fitted to accessories that have a motor as a drive for example the R8131 Hornby Operating Conveyor or the R8132 Hornby Tipper set.

Occupancy Decoder

A unit that can detect the presence of a locomotive on a specific section of track and can provide the appropriate information as 'return' data.

Power Bus

Copper strip or wires that can relay power from a Power Booster to the track.

Power Booster/Power Station

A Power Booster or Power Station is as the name implies there to provide a boost of power to the track. This can occur if a larger than normal quantity of locomotives are required to be running on the track at the same time. If the transformer already fitted cannot handle this number then it will be necessary to section the layout and fit a Power Booster.

This Booster will not only provide more ampage to the drive locomotives but also boost the signals to the Decoders. All Boosters fitted must still be connected to the Power Station.

Programming

The process of assigning an Address to a locomotive or accessory (points or signals). The process of programming sends a signal containing a numerical identifier to the locomotive being programmed.

Programming Track

A section of track isolated from the main layout purposely for programming locomotives. Programming on a Programming Track negates the requirement of removing other locomotives from the main layout.

Glossary (Continued)

Speed Steps

A variable voltage increase used to control motor speeds. Decoders can set the output power for each speed step.

Stall Current

Stall Current is the maximum current draw in amperes that a locomotive is capable of when stalled. If the armature of a motor is prevented from turning and the maximum voltage is applied the current draw of the motor is known as the 'Stall Current'.

Throttle Notches

Determines whether a locomotive is controlled with 14, 27, 28 or 128 speed steps.

XpressNet

A high-speed communication protocol used for connecting Digital input devices together.

XpressNet (XBUS) Input Devices

Devices using the XpressNet protocol to control a digital layout.

LCD Display Guide

LA	Locomotive Address.	CA	Clear All
AC	Acceleration	F0/1/2/3 etc	Functions 1, 2, 3 etc
dE	Deceleration	C5	Control Station
Fd	Forward Direction	HC	Hand Controller
rd	Reverse Direction	H5	Speed Step 128
E5	Emergency Stop	CE	Command Error from
A1	Address One		XpressNet
A2	Address Two	OL	Short Circuit or Overload

Trouble Shooting

Locomotive will not run

Check that all the wiring is correctly connected to the track and Controller and that the transformer is plugged into the wall and is switched on.

Ensure that the correct loco address is displayed on the LCD.

Check that the "STOP" button has not been pressed accidentally.

The trains do not run smoothly

The locomotives require a clean track so that they can receive their information from the Select, therefore ensure that the track is clean. Use an R8087 Track Rubber to remove dirt from the track and wheels of the locomotive. Do not use any other abrasive material as this will permanently damage the track and/or wheels.

All locomotives move off together

Make sure that a locomotive has not been given a new address while other locomotives have been on the same track. To avoid this it is advisable to use a Programming Track to add new addresses to locomotives and Hornby Point/Accessory Decoders. See page 22

All locomotives appear to have the same Acceleration/Deceleration levels.

All locomotives appear to have the same Acceleration/Deceleration levels

Make sure that a locomotive has not been programmed with acceleration and deceleration levels while other locomotives have been on the same track. To avoid this happening it is advisable to use a Programming Track to add new addresses to locomotives and Hornby Point / Accessory Decoders. See page 22

System keeps cutting out

Check that there is no metal across the track that may be causing a short circuit. Also check that the system is not being overloaded by too many locomotives trying to run at the same time.

The Lamp transformer included with the **Select** should within reason be capable of providing enough power to run three locomotives. If in doubt consult your local dealer or the Hornby DCC Helpline.

Do not connect any other controller to the Hornby Select other than a Hornby Elite or another Hornby Select Unit. When using a Select with the Hornby Elite ensure that the Select is not connected directly to a mains transformer. Similarly, when using two Selects which are connected together only one of them must be connected to a mains transformer.

Do not run coreless motored locomotives on a DCC layout without them having a decoder fitted.

If in doubt please contact Hornby or your local dealer for advice.

Tel. +44 (0)1843 233525 Email. help.dcc@hornby.com Web. <http://www.hornby.com>
Hornby PLC, Westwood Industrial Estate, Margate, Kent CT9 4JX.

Safety Notes

- This product is intended for indoor use only.
- This Select Digital Control system is only to be operated with the Hornby recommended transformers.
- The transformer included is not a toy; it is a “Transformer for Toys”.
- Before use the transformer should be examined for damage to the casing, plug pins and cables. In the event of such damage, the Select unit should not be used until the transformer is replaced with a new Hornby recommended unit. Never attempt to open the unit yourself.
- Before cleaning any part, disconnect the transformer from the mains electricity supply.
- Do not use liquid for cleaning.
- Wires without a connecting means are not to be inserted into outlets.
- The output terminals of the transformers must not be connected directly, or indirectly, to the output of any other mains power supply.

Guarantee

All Hornby products are guaranteed against defects in materials and workmanship for a period of 6 months and Hornby Digital electronics for 1 months from the date of purchase.

To qualify for the guarantee, the product must have been used and maintained according to the manufacturers instructions, and will only be covered when used in conjunction with officially approved Hornby accessories and components. While every possible care and attention has been taken by Hornby to ensure that the product arrives to you in pristine condition, we cannot accept liability for any subsequent misuse of the product. It is the responsibility of the consumer to ensure that the product is maintained as per the servicing details provided.

For reliable programming it is important that the track and wheels of all locomotives and wagons used with the Select Digital system are kept clean. If any defect occurs during the guarantee period, then the item in the first instance should be returned to the place of original purchase. Alternatively, if any such defect occurs during the period of guarantee, then please contact your Hornby Service dealer for advice. Or, the product (or component), may be forwarded to Hornby Hobbies Ltd, carefully packed, with a covering letter enclosed giving full details to:

Repairs Department, Hornby Hobbies Ltd, Westwood, Margate, Kent CT9 4JX. UK.

Please include a copy of the original sales document showing the product reference number, date of purchase and from where purchased and any other requested information relating to the product. Please obtain a Certificate of Posting at the time of despatch.

Exclusions

Subject to the exclusions below, the product will be repaired or replaced free of charge, if the problem is found to be due to either workmanship or materials. The repair/replacement will be provided as promptly as possible without significant inconvenience to the consumer:

- The fault has been caused or is attributable to mis-use, negligent use or used contrary to the manufacturers recommendations.
- Accidental physical damage.

This guarantee is valid for products purchased in the United Kingdom and is in addition to, and does not diminish, your statutory rights. For further advice about your statutory rights contact your local authority Trading Standards Department or Citizens Advice Bureau.

This warranty only covers Hornby manufactured items. Please retain these details and address for future reference.



Waste electrical products should not be disposed of with household waste. Please recycle where facilities exist. Check with your Local Authority or retailer for recycling advice.